



BP
BERNET
PRO



TRADI'REV

By REVEAU

MR
MENUISERIE
REVEAU



TRADI'REV



MADE IN
FRANCE

**AUTHENTICITÉ
&
CARACTÈRE**

CLASSEMENT AEV
A*4 - E* 7B - V* C3

PERFORMANCE THERMIQUE
de 1.36 à 1,45 W/m².k

LA GAMME TRADI'REV Véritable menuiserie à l'ancienne, mouton et gueule de loup, la gamme Tradi'Rev est ferrée sur paumelles, sa fermeture se fait avec une crémone en applique. Disponible en 56 et 60mm d'épaisseur, avec un battement réduit à 137mm et un double joint en base. L'assemblage est à double enfourchement. Il est non marqué. La gamme obtient un affaiblissement acoustique performant. En options, volet intérieur et espagnolette.



Couleurs de votre choix
selon le nuancier RAL,
lasure et bi-coloration possible

TRADI'REV

By REVEAU

MR
MENUISERIE
REVEAU



OPTIONS

VOLETS INTÉRIEURS :

Véritable avantage de la gamme à l'ancienne, optez pour l'option volets intérieurs. Disponible en un ou deux vantaux, ils sont ferrés sur des paumelles trois branches.



ESPAGNOLETTE :

Quincaillerie de style, adoptez l'espagnolette pour vos menuiseries.

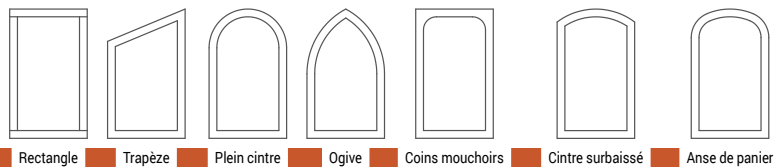

FORMES

PERFORMANCE THERMIQUE

VITRAGE	Double vitrage 4-20arg-4FE						
DESCRIPTIF	Ug = 1,1 W/m².K Fs=0.63 TI=82%						
TYPE D'INTERCALAIRE	Warm Edge						
ESSENCE DE BOIS	Bossé (0,15 W/m².K)			Chêne (0,18 W/m².K)			
TYPE DE CHÂSSIS	TYPE DE SEUIL	Uw	Sw	TLw	Uw	Sw	TLw
Fenêtre 2 vantaux*	Appui bois	1,36	0,43	55%	1,42	0,43	55%
Porte fenêtre 2 vantaux*	Appui bois	1,38	0,42	53%	1,44	0,42	53%

* selon dimension conventionnelle



TRADI'REV

By REVEAU

MR
MENUISERIE
REVEAU

Finition des volets
réalisée par le client



Petits bois
coins arrondis en option



KALI'CIEL

REVEAU

MR
MENUISERIE
REVEAU



KALI'CIEL



MADE IN
FRANCE

ESTHÉTIQUE & TRADITION

CLASSEMENT AEV
A*4 - E*7B - V*C2

PERFORMANCE THERMIQUE
de 1.36 à 1.54 W/m2.k

LA GAMME KALI'CIEL reconnue pour améliorer la transmission lumineuse grâce à son battement central réduit à 123mm, la gamme Kali'Ciel bénéficie automatiquement du double joint. Disponible en 58 et 64mm d'épaisseur, elle dispose en option du système oscillo-battant. L'assemblage est à double enfourchement.

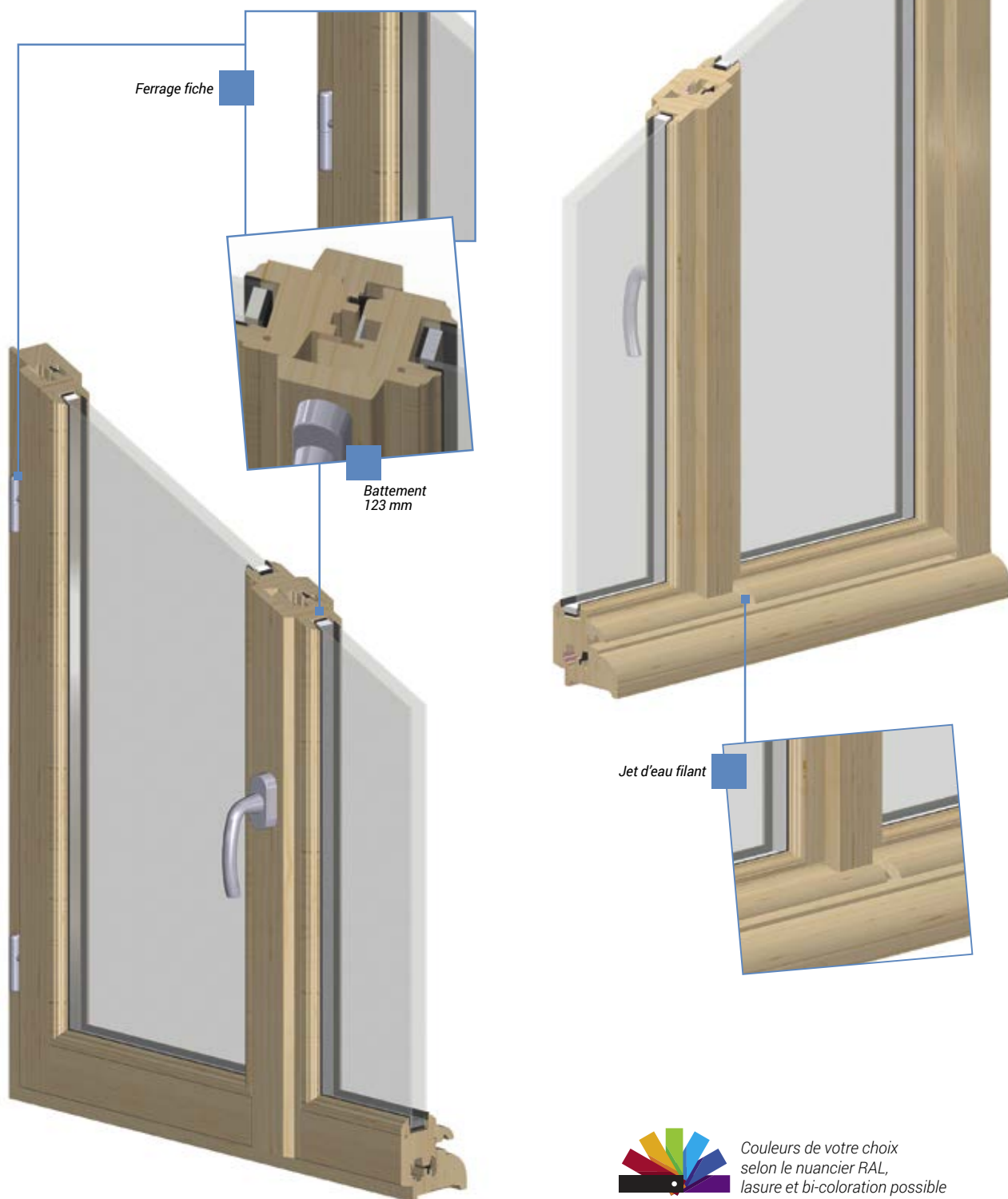

Couleurs de votre choix
selon le nuancier RAL,
lasure et bi-coloration possible



OPTIONS

OSCILLO-BATTANT :

Avec le système oscillo-battant, ventilez votre maison plus facilement. Bénéficiez automatiquement du ferrage symétrique.



FAUSSE CRÉMONE :

Poignée de style, imitant la véritable crémonne, cette quincaillerie est disponible avec bouton ou bec de canne lorsque vous choisissez le système OB.



Bec de canne



Bouton crémonne

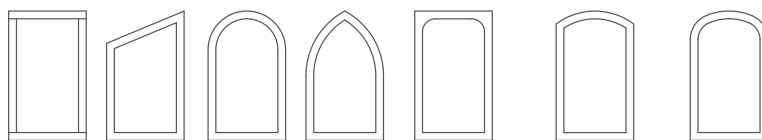

Rectangle

Trapèze

Plein cintre

Ogive

Coin mouchoirs

Cintre surbaissé

Anse de panier

FORMES

PERFORMANCE THERMIQUE

VITRAGE		Double vitrage 4-20arg-4FE								
DESRIPTIF		Ug = 1,1 W/m².K Fs=0.63 TI=82%								
TYPE D'INTERCALAIRE		Warm Edge								
ESSENCE DE BOIS		Mélèze et Pin Sylvestre (0,13 W/m².K)			Bossé (0,15 W/m².K)			Chêne (0,18 W/m².K)		
TYPE DE CHÂSSIS	TYPE DE SEUIL	Uw	Sw	TLw	Uw	Sw	TLw	Uw	Sw	TLw
Fenêtre 2 vantaux*	Appui bois	1.36	0.41	53%	1.40	0.42	53%	1.47	0.42	53%
Porte fenêtre 2 vantaux*	Seuil alu	1.42	0.41	53%	1.47	0.41	53%	1.54	0.42	53%

* selon dimension conventionnelle

Menuiserie avec imposte cintre surbaissé



Ensemble de menuiseries avec petits bois collés



MANGROVE

By REVEAU



MADE IN FRANCE

MANGROVE

SIMPLICITÉ
&
FIABILITÉ

CLASSEMENT AEV
A*4 - E*6B - V*B3

PERFORMANCE THERMIQUE
de 1.37 à 1.55 W/m2.k

LA GAMME MANGROVE adaptable à tous les types de chantiers, la gamme Mangrove reprend le standard de la fenêtre jeu de 3mm. L'assemblage est à double enfourchement. Il est non marqué. Disponible en 56 et 60 mm d'épaisseur, sa fabrication permet la mise en œuvre de l'ouverture extérieure.





OPTIONS

OUVERTURE EXTÉRIEURE :

L'ouverture extérieure est de mise dans les bâtiments accueillant du public. Elle permet aussi de diminuer l'encombrement à l'intérieur d'une pièce.

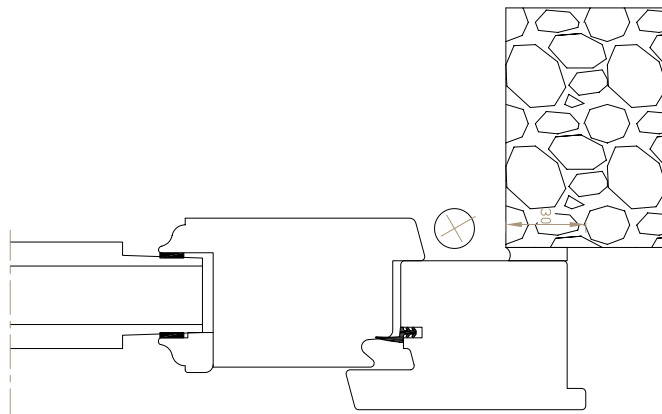

■ Vue de coupe

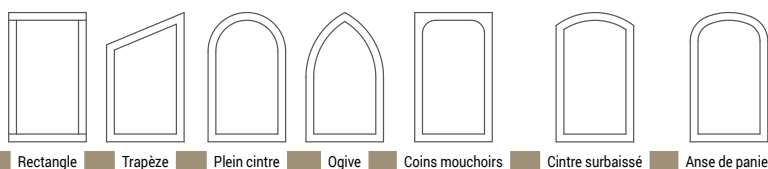

FORMES

PERFORMANCE THERMIQUE

VITRAGE		Double vitrage 4-20arg-4FE								
DESRIPTIF		Ug = 1,1 W/m².K Fs=0.63 TI=82%								
TYPE D'INTERCALAIRE		Warm Edge								
ESSENCE DE BOIS		Mélèze et Pin Sylvestre (0,13 W/m².K)			Bossé (0,15 W/m².K)			Chêne (0,18 W/m².K)		
TYPE DE CHÂSSIS	TYPE DE SEUIL	Uw	Sw	TLw	Uw	Sw	TLw	Uw	Sw	TLw
Fenêtre 2 vantaux*	Appui bois	1.37	0.42	54%	1.43	0.42	54%	1.48	0.42	54%
Porte fenêtre 2 vantaux*	Seuil alu	1.42	0.41	53%	1.48	0.41	53%	1.55	0.41	53%

* selon dimension conventionnelle

Château Kergonano.



Renovation de l'ancien
avec petits bois collés et imposte fixe



EXCELLENCE
BOIS

By REVEAU
MR
MENUISERIE
REVEAU



Parc de Brantère, 56190 - LE GUERNON

EXCELLENCE BOIS

PERFORMANCE
&
MODERNITÉ

CLASSEMENT AEV
A*4 - E*6B - V*C3

PERFORMANCE THERMIQUE
de 0,89 à 1,47 W/m².k



MADE IN
FRANCE



LA GAMME EXCELLENCE BOIS conforme à la réglementation thermique 2012 et au BBC, la gamme Excellence Bois est à double enfourchement et à arasement marqué ce qui permet d'optimiser la tenue des finitions. Le système de joint à 2 barrières apporte un meilleur confort thermique et acoustique. Disponible en 68, 78 et 92 mm d'épaisseur, elle intègre en option le système oscillo-battant avec ferrage symétrique.



 Couleurs de votre choix
selon le nuancier RAL,
lasure et bi-coloration possible



OPTIONS

PROTECTEUR DE PLUIE :
Système de protection de votre
pièce d'appui. Coloris au choix.



POIGNEE CENTREE :

Battent centré avec
possibilité d'inclure égale-
ment en options une fausse
crémone et/ou une crémone
de semi-fixe.

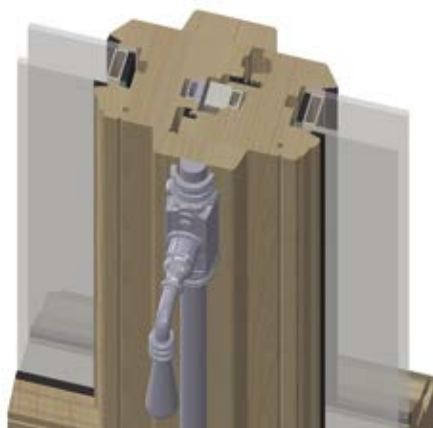

MOULURE DOUCINE :

En plus de la pente 15,
retrouvez notre moulure
traditionnelle.

APPUI ARRONDI :

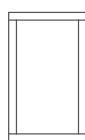
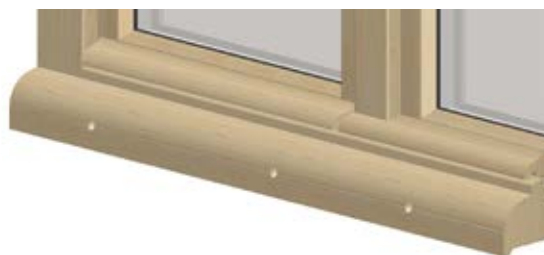

Rectangle

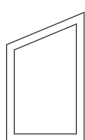

Trapèze

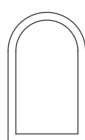

Plein cintre

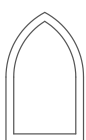

Ogive

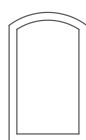

Cintre surbaissé

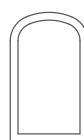

Anse de panier

FORMES

PERFORMANCE THERMIQUE

VITRAGE		Double vitrage 4-20arg-4FE								
DESRIPTIF		Ug = 1,1 W/m².K Fs=0.63 TI=82%								
TYPE D'INTERCALAIRE		Warm Edge								
ESSENCE DE BOIS		Mélèze et Pin Sylvestre (0,13 W/m².K)			Bossé (0,15 W/m².K)			Chêne (0,18 W/m².K)		
TYPE DE CHÂSSIS	TYPE DE SEUIL	Uw	Sw	TLw	Uw	Sw	TLw	Uw	Sw	TLw
Fenêtre 2 vantaux*	Appui bois	1.32	0.40	51%	1.36	0.41	51%	1.42	0.41	51%
Porte fenêtre 2 vantaux*	Seuil alu	1.35	0.37	46%	1.41	0.37	46%	1.48	0.37	46%

* selon dimension conventionnelle



EXCELLENCE
BOIS

By REVEAU



Parc de Branféré,
56190 LE GUERNO

Parc de Branféré, 56190 LE GUERNO



EXCELLENCE
MIXTE

BY ANGLAT
MR
MENUISERIE
REVEAU



EXCELLENCE MIXTE



MADE IN
FRANCE

CONFORT
&
ESTHÉTISME

CLASSEMENT AEV
A*4 - E*7B - V*C3

PERFORMANCE THERMIQUE
de 1,06 à 1,55 W/m².k

LA GAMME EXCELLENCE MIXTE est une menuiserie en bois avec capotage aluminium, elle se décline en 68 et 78 mm d'épaisseur. Elle est assemblée par double enfourchement et bénéficie d'un système de joint à 3 barrières, qui apporte un meilleur confort thermique et acoustique. Elle intègre en option le système oscillo-battant avec ferrage symétrique.

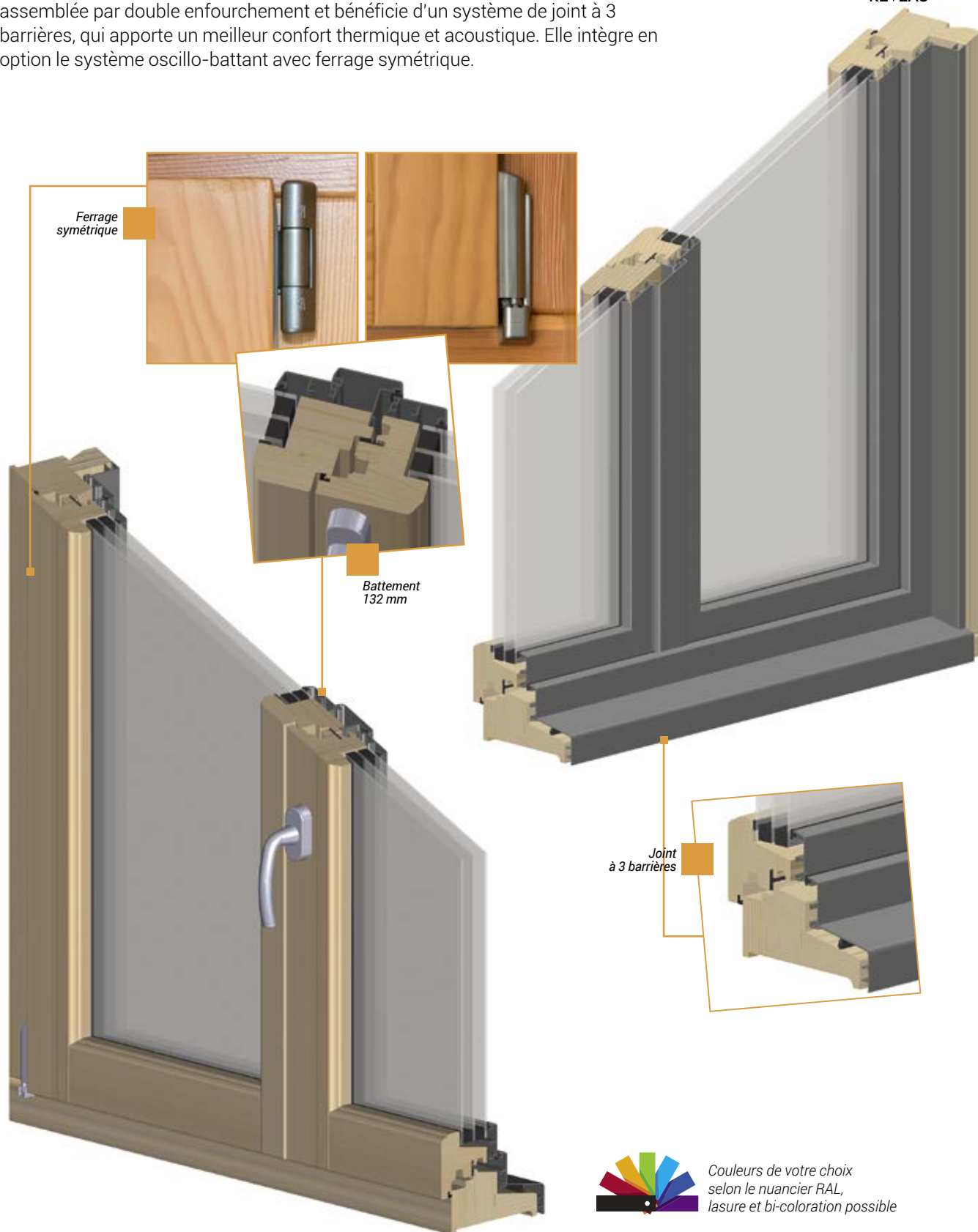

Ferrage
symétrique

Battement
132 mm

Joint
à 3 barrières



Couleurs de votre choix
selon le nuancier RAL,
lasure et bi-coloration possible



OPTIONS

OUVERTURE EXTÉRIEURE :

L'ouverture extérieure est de mise dans les bâtiments accueillant du public. Elle permet aussi de diminuer l'encombrement à l'intérieur d'une pièce.



OSCILLO BATTANT
possible sur cette gamme.

CAPOTAGE ALUMINIUM
labellisé Qualicoat et Qualimarine.

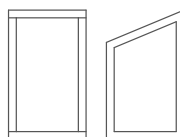

Rectangle

Trapèze

FORMES

PERFORMANCE THERMIQUE

VITRAGE	Double vitrage 4-20arg-4FE					
DESSCRIPTIF	Ug = 1,1 W/m ² .K Fs 0.63 TI=82%					
TYPE D'INTERCALAIRE	Warm Edge					
ESSENCE DE BOIS	Pin Sylvestre (0,13 W/m ² .K)			Chêne (0,18 W/m ² .K)		
TYPE DE CHÂSSIS (68 MM)	Uw	Sw	TLw	Uw	Sw	TLw
Fenêtre 2 vantaux*	1.4	0.42	53%	1.5	0.45	57%
Porte fenêtre 2 vantaux*	1.4	0.42	53%	1.4	0.45	57%

* selon dimension conventionnelle

EXCELLENCE
MIXTE

By REVEAU

MR
MENUISERIE
REVEAU



École de Combrand



COULISSANT
BOIS

By REVEAU

MR
MENUISERIE
REVEAU



Bonnet Architecture, 35 SAINT-MALO

COULISSANT BOIS

DESIGN
&
ERGONOMIE

PERFORMANCE THERMIQUE
de 1,5 à 1,7 W/m².k

MADE IN
FRANCE

LA GAMME COULISSANT BOIS présente de nombreux schémas pour s'adapter aux différentes configurations de votre intérieur. Nous vous proposons un couissant en 56 mm ou 68 mm d'épaisseur et pouvant atteindre jusqu'à 6m de long.

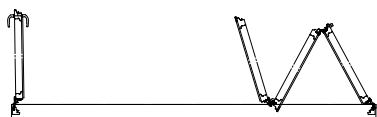

Pliant coulissant disponible, appelé aussi couissant accordéon.
Plus d'informations auprès de notre équipe.

PLIANT COULISSANT



Poignées de couissant



Couleurs de votre choix selon le nuancier RAL

Couissant 4 vantaux dont 2 coulissants et 2 fixes



Possibilité de seuil encastrable



**COULISSANT
MIXTE**

By REVEAU

MR
MENUISERIE
REVEAU



**COULISSANT
MIXTE**

**HARMONIE
&
ÉLÉGANCE**

MADE IN
FRANCE

LA GAMME COULISSANT MIXTE se décline sous différents schémas permettant de s'adapter à votre intérieur. Retrouvez la chaleur du bois à l'intérieur et la modernité de l'alu à l'extérieur.

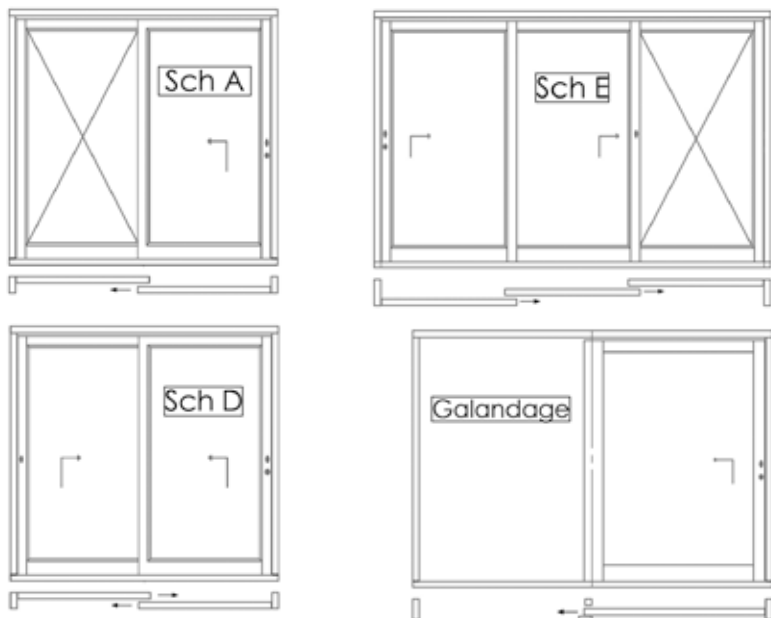

Poignée et seuil de coulissant

FORMES



Couleurs de votre choix
selon le nuancier RAL



Coulissant
deux vantaux



QUINCAILLERIE BOIS



POIGNÉE
FENÊTRES

CRÉMONE
RY 59

ESPAGNOLETTE
EN OPTION

ESPAGNOLETTE
AVEC
AGRAFFE
EN OPTION

FAUSSE
CRÉMONE
ELEGANCE
EN OPTION

TRADI'REV



MANGROVE



KALI'CIEL



EXCELLENCE
BOIS



EXCELLENCE
MIXTE



BLANC



NOIRE



FER DÉCOR



VIEUX LAITON



LAITONNÉE



TON ALU



COULEUR
STANDARD

TON ALU

NOIRE

NOIRE

NOIRE

NOIRE



FAUSSE
CRÉMONE
ÉLÉGANCE
EN OPTION

FAUSSE
CRÉMONE
OB
EN OPTION

PAUMELLE
VASE
TURLUPET

PAUMELLE
VASE
BOULE

CACHES
FICHES
TURLUPET

CACHES
FICHES
EN OPTION

FICHE
ANUBA



NOIRE



NOIRE



NOIRE



ASSORTI
AVEC
LA POIGNÉE



TON ALU



PRODUITS SPÉCIAUX



Grâce au savoir-faire de nos menuisiers qualifiés,
nous intervenons dans la restauration d'éléments anciens.



Simple vitrage sous mastic
Assemblage à coupe d'onglet
Ferrage par fiches à larder
Fermeture par espagnolette



Fiche à larder



Targette

ou targette en fer forgé
Forme complexe



Imposte avec petits bois collés, copie à l'identique de l'existant



Espagnolette panneton et agrafe



MOULURES ET PERSONNALISATION



Votre menuiserie s'adapte à votre image, choisissez parmi nos 5 moulures, c'est sans plus-value !



STANDARD
Doucine
intérieure
et extérieure



CONTEMPORAIN
Pente intérieure
et extérieure,
pièce d'appui et
jet d'eau à pente



**Nos pièces d'appui
sont disponibles
avec appui arrondi,
droit ou sur-mesure.**

**Questionnez
notre équipe.**

TRADITION
Imitation mastic
extérieure
et quart de rond
intérieur avec
jet d'eau doucine

MOULURES

Adaptables sur toutes les gammes, hors Excellence et Coulissant



Doucine

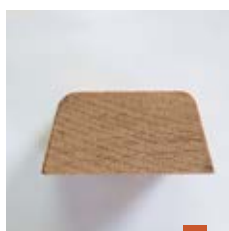

Pente 15



Quart de rond



Pastum



Pente 40
imitation mastic

PARCLOSES





PETITS BOIS

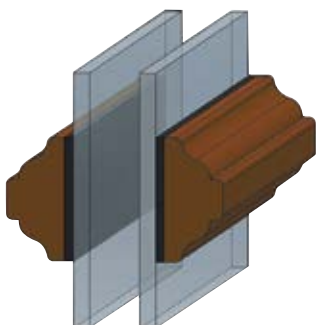

Petits bois collés
 Petit bois collé
 largeur 30 mm.
Il est disponible dans les cinq moulures de nos ouvrants.

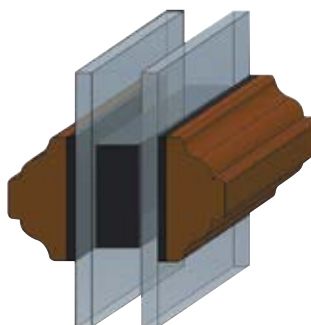

Petits bois collés avec intercalaire fictif
 Petit bois collé avec intercalaire fictif. Alternative aux petits bois mortaisés.
Permet un petit bois plus fin que le petit bois mortaisés (30 mm).

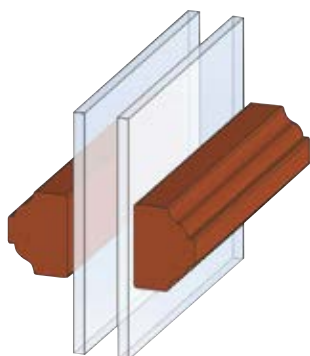

Cadre à croisillons
 Cadre à moulure doucine et largeur 30 mm.
Cadre amovible sur charnière pour faciliter le nettoyage des carreaux.



Petits bois mortaisés
 Petit bois mortaisé largeur 53 mm.
*Il est assemblé par tenon dans le vantail.
 C'est le petit bois traditionnel adapté aux normes actuelles.*

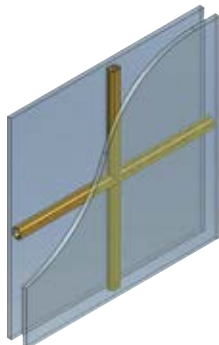

Petits bois incorporés
 Différents coloris et tailles de petits bois incorporés sur demande (laiton, alu, blanc...)

PANNEAUX PORTES FENÊTRES



Imaginez vos menuiseries selon vos envies, de nombreux panneaux pour vos portes fenêtres sont réalisables.

Rainuré, tas de sable, plate-bande, embrevé, pointe de diamant, panneau lisse, empilage de traverse...

Empilage de traverse



plate bande



Rainuré



*Tas de sable extérieur
Plate bande intérieure*